



*Ranieri*®  
INTERNATIONAL

BOATS & INFLATABLE BOATS



INFLATABLE BOATS  
*Made in Italy*



**Artigianato d'eccellenza. Passione e tecnologia.**

Fin dalla sua fondazione nel 1966, il Cantiere guidato da Pietro Ranieri, ha interpretato le migliori tradizioni della cantieristica e dell'artigianato italiano di elevato profilo qualitativo, in modo dinamico e tecnologicamente avanzato. Cuore e spirito del fondatore si sono da sempre focalizzati su imbarcazioni d'eccellenza per offrire agli appassionati opere nautiche confortevoli, performanti e sicure. Oggi, grazie al coinvolgimento della seconda generazione e a un rinnovato apporto di entusiasmo e passione e una nuova visione di marketing internazionale, si è avviato un processo di crescita straordinaria che permetterà al Cantiere di confrontarsi con le migliori eccellenze mondiali, offrendo imbarcazioni con standard qualitativi elevatissimi. La straordinaria gamma della Ranieri International, la più ampia in Europa per le barche rigide e pneumatiche, è la base per il raggiungimento dei futuri successi internazionali. Arte ed etica della cantieristica italiana per gli appassionati di nautica di tutto il mondo.

**The craft excellence. Passion and technology.**

Since its founding in 1966, the Shipyard led by Pietro Ranieri, has interpreted the best traditions of Italian shipbuilding and crafts with an high quality profile, in a dynamic and technologically advanced way. The heart and spirit of the founder have always focused on excellence boats really comfortable with a good performance and safe. Today, thanks to the involvement of the second generation and a new enthusiastic vision of international marketing, has been launched an extraordinary growth process that will allow the Shipyard to compete with the best global excellence, offering boats with high standard quality. The extraordinary line up of Rainier International, the wider in Europe for rigid and pneumatic boats, is the basis for the achievement of future international success. Art and ethics of the Italian shipbuilding for fans of all the world.

**Artisanat d'excellence. Passion et technologie.**

Dès sa fondation en 1966, le chantier dirigé par Pietro Ranieri a interprété de manière dynamique et technologiquement à l'avant-garde, la meilleure tradition des chantiers et de l'artisanat italiens. Le cœur et l'esprit du fondateur se sont toujours focalisés sur le produit d'excellence pour offrir aux passionnés des embarcations confortables, performantes et sûres. Aujourd'hui, grâce à l'enthousiasme et l'engagement de la seconde génération, la passion et une nouvelle vision du marketing international, le chantier s'est engagé dans une phase de croissance soutenue qui permet désormais de se confronter aux meilleurs concurrents mondiaux. L'extraordinaire gamme de produits parmi la plus complète en Europe de bateaux et de semi-rigides constitue la base des futurs succès de l'entreprise. Art et éthique des chantiers italiens pour les passionnés de nautisme du monde entier.

**La excelencia artesanal. Pasion y tecnologia.**

Desde su fundacion en 1966, el Astillero dirigido por Pietro Ranieri ha sabido conjugar la mejor tradicion italiana en la construccion de embarcaciones con un alto perfil de calidad usando un metodo dinamico y tecnologicamente avanzado. El corazon y espiritu del fundador siempre ha estado enfocado en construir embarcaciones excelentes, muy confortables, seguras y con muy buenas prestaciones. Hoy, gracias a la entrada de la segunda generacion con un renovado aporte de energia y pasion además de una vision amplia del marketing internacional se iniciado un gran proceso de crecimiento que permite al astillero competir a nivel en primera line a nivel global ofreciendo embarcaciones altissima calidad. La extraordinaria gama de Ranieri International, la mas amplia de Europa de embarcaciones rigidas y neumaticas es la base para lograr el futuro éxito internacional. Arte y ética de nuestro astillero italiano para los fans de todo el mundo.

**Exzellentes Handwerk. Leidenschaft und technologie.**

Seit der Gründung der Schiffswerft im 1966, geführt von Herrn Pietro Ranieri, hat seine Leidenschaft zur Tradition mit italienischem Handwerk verbunden um ein qualitativ, hochstehendes Profil einer dynamischen, fortgeschrittenen Technologie zu präsentieren. Um den Liebhabern ein nautisch, komfortables Werk zu erschaffen hat der Gründer sich immer mit Herz und Seele auf exzellente Bootsbauten fokussiert. Heute, dank der Einbindung der zweiten Generation sowie einer Erneuerung der Einbringung von Enthusiasmus und Leidenschaft, ist eine neue, internationale Marketingvision entstanden. Es wurde ein einzigartiger Wachstumsprozess eingeleitet, welcher der Schiffswerft die Möglichkeit eröffnet hat sich mit den weltweit besten Herstellern messen zu können und Ihnen ein qualitativ hochwertiges Boot bieten zu können. Die einzigartige Bandbreite der Ranieri International, die umfangreichste für steife Boote in Europa, ist die Basis um ein internationaler Erfolg zu erreichen. Kunst und Ethik der italienischen Schiffswerft für Liebhaber von der Schifffahrt in der ganzen Welt.



Antonio, Pietro e Salvatore Ranieri





## CAYMAN LINE

Pag. 2 *Cayman 45.0 Cruiser*

---

Pag. 6 *Cayman 38.0 Executive*

Pag. 10 *Cayman 35.0 Executive*

Pag. 14 *Cayman 28.0 Executive*

---

Pag. 18 *Cayman 27.0 Sport Touring*

Pag. 22 *Cayman 26.0 Sport Touring*

Pag. 24 *Cayman 23.0 Sport Touring*

---

Pag. 26 *Cayman 26.0 Sport*

Pag. 28 *Cayman 23.0 Sport*

Pag. 30 *Cayman 21.0 Sport*

Pag. 32 *Cayman 19 Sport*







---

Pag. 34 *Cayman One Luxury tender*



# CAYMAN 45.0 CRUISER

## CAYMAN LINE

	Lunghezza F.T. <b>13,80 m</b> Length overall <b>45' 6"</b>
	Larghezza F.T. <b>4,20 m</b> Beam <b>13' 8"</b>
	Diametro tubolari <b>0,65 m</b> Tubular diameter <b>2' 13"</b>
	Camere stagne <b>10</b> T. compartments
	Persone <b>16</b> Persons
	Posti letto <b>4</b> Beds
	Peso <b>9.500 Kg</b> Weight <b>20.943 lbs</b>
	Motorizzazione <b>2 - 3</b> Engine
	Potenza Min. <b>900 Hp</b> Min. power
	Potenza Max <b>1.450 Hp</b> Max power
	Gambo <b>2XXL-3XXL</b> Shaft Length
	Carburante <b>1450 Lt</b> Fuel tank <b>383 Gal</b>
	Acqua <b>200 Lt</b> Water tank <b>53 Gal</b>
	Categoria <b>B</b> Category
	















SECOND CABIN



SECOND CABIN



# CAYMAN 38.0 EXECUTIVE

CAYMAN LINE

TROFEO

 Lunghezza F.T. **11,70 m**

Length overall **38' 4"**

 Larghezza F.T. **3,80 m**

Beam **12' 5"**

 Diametro tubolari **0,65 m**

Tubular diameter **2' 13"**

 Camere stagne **8**

T. compartments

 Persone **24**

Persons

 Posti letto **4**

Beds

 Peso **3.500 Kg**

Weight **7.716 lbs**

 Motorizzazione **2 - 3**

Engine

 HP MIN Potenza Min. **600 Hp**

Min. power

 HP MAX Potenza Max **1.200 Hp**

Max power

 Gambo **2XXL-3XXL**

Shaft Length

 Carburante **725 Lt**

Fuel tank **184 Gal**

 Acqua **150 Lt**

Water tank **40 Gal**

 Categoria **B**

Category











FIRST CABIN







SECOND CABIN







# CAYMAN 35.0 EXECUTIVE

CAYMAN LINE

*SUPER SPORT*

 Lunghezza F.T. **10,80 m**

Length overall **35' 4"**

 Larghezza F.T. **3,80 m**

Beam **12' 5"**

 Diametro tubolari **0,65 m**

Tubular diameter **2' 13"**

 Camere stagne **8**

T. compartments

 Persone **24**

Persons

 Posti letto **4**

Beds

 Peso **3.200 Kg**

Weight **7.055 lbs**

 Motorizzazione **2**

Engine

 Potenza Min. **500 Hp**

Min. power

 Potenza Max **900 Hp**

Max power

 Gambo **2 XXL**

Shaft Length

 Carburante **610 Lt**

Fuel tank **160 Gal**

 Acqua **150 Lt**

Water tank **40 Gal**

 Categoria **B**

Category











FIRST CABIN







SECOND CABIN





# CAYMAN 28.0 EXECUTIVE

## CAYMAN LINE

 Lunghezza F.T. **8,60 m**  
Length overall **28' 2"**

 Larghezza F.T. **3,30 m**  
Beam **10' 8"**

 Diametro tubolari **0,65 m**  
Tubular diameter **2' 13"**

 Camere stagne **6**  
T. compartments

 Persone **20**  
Persons

 Posti letto **2**  
Beds

 Peso **2.000 Kg**  
Weight **4.410 lbs**

 Motorizzazione **1 - 2**  
Engine

 **HP** **300 Hp**  
Min. power

 **HP** **600 Hp**  
Max power

 Gambo **1 XXL-2XL**  
Shaft Length

 Carburante **420 Lt**  
Fuel tank **111 Gal**

 Acqua **80 Lt**  
Water tank **21 Gal**

 Categoria **B**  
Category



















# CAYMAN 27.0 SPORT TOURING

## CAYMAN LINE

 Lunghezza F.T. **8,60 m**  
Length overall **28' 20"**

 Larghezza F.T. **3,20 m**  
Beam **10' 5"**

 Diametro tubolari **0,65 m**  
Tubular diameter **2' 23"**

 Camere stagne **6**  
T. compartments

 Persone **20**  
Persons

 Peso **1.800 Kg**  
Weight **3.968 lbs**

 Motorizzazione **1 - 2**  
Engine

 Potenza Min. **250 Hp**  
Min. power

 Potenza Max **500 Hp**  
Max power

 Gambo **1 XXL-2XL**  
Shaft Length

 Carburante **420 Lt**  
Fuel tank **111 Gal**

 Acqua **80 Lt**  
Water tank **21 Gal**

 Categoria **B**  
Category













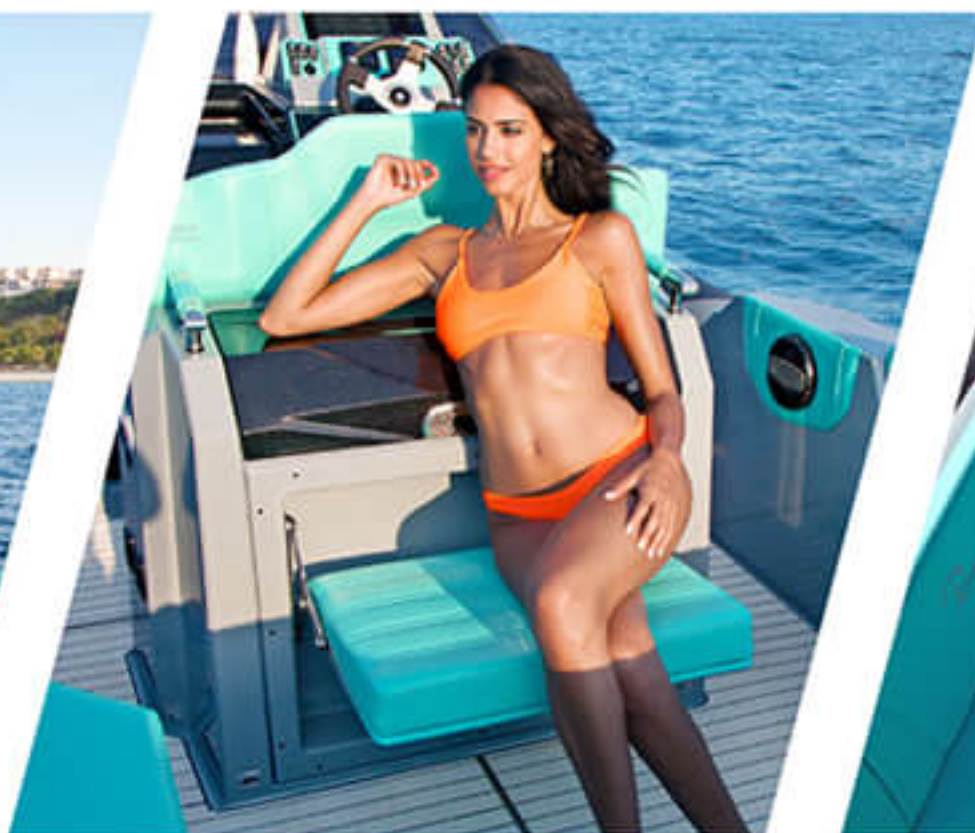





# CAYMAN 26.0 SPORT TOURING

## CAYMAN LINE

 Lunghezza F.T. **7,80 m**  
Length overall **25' 6"**

 Larghezza F.T. **2,80 m**  
Beam **9' 18"**

 Diametro tubolari **0,60 m**  
Tubular diameter **1' 95"**

 Camere stagne **5**  
T. compartments

 Persone **18**  
Persons

 Peso **1.200 Kg**  
Weight **2.646 lbs**

 Motorizzazione **1**  
Engine

 HP MIN Potenza Min. **175 Hp**  
Min. power

 HP MAX Potenza Max **250 Hp**  
Max power

 Gambo **XL**  
Shaft Length

 Carburante **260 Lt**  
Fuel tank **69 Gal**

 Acqua opt. **60 Lt**  
Water tank **opt. 16 Gal**

 Categoria **B**  
Category











# CAYMAN 23.0 Sport Touring

## CAYMAN LINE

 Lunghezza F.T. **7,10 m**  
Length overall **23' 30"**

 Larghezza F.T. **2,80 m**  
Beam **9' 18"**

 Diametro tubolari **0,60 m**  
Tubular diameter **1' 95"**

 Camere stagne **5**  
T. compartments

 Persone **16**  
Persons

 Peso **750 Kg**  
Weight **1.653 lbs**

 Motorizzazione **1**  
Engine

 **HP** Min. **100 Hp**  
Min. power

 **HP** Max. **250 Hp**  
Max power

 Gambo **XL**  
Shaft Length

 Carburante **205 Lt**  
Fuel tank **54 Gal**

 Acqua opt. **45 Lt**  
Water tank opt. **12 Gal**

 Categoria **B**  
Category











# CAYMAN 26.0 SPORT

## CAYMAN LINE

 Lunghezza F.T. **7,80 m**  
Length overall **25' 6"**

 Larghezza F.T. **2,80 m**  
Beam **9' 18"**

 Diametro tubolari **0,60 m**  
Tubular diameter **1' 95"**

 Camere stagne **5**  
T. compartments

 Persone **18**  
Persons

 Peso **1.150 Kg**  
Weight **2.535 lbs**

 Motorizzazione **1**  
Engine

 **HP** Min. **175 Hp**  
Min. power

 **HP** Max. **250 Hp**  
Max power

 Gambo **XL**  
Shaft Length

 Carburante **260 Lt**  
Fuel tank **69 Gal**

 Acqua **opt. 60 Lt**  
Water tank **opt. 16 Gal**

 Categoria **B**  
Category











# CAYMAN 23.0 SPORT

## CAYMAN LINE

 Lunghezza F.T. **7,10 m**  
Length overall **23' 30"**

 Larghezza F.T. **2,80 m**  
Beam **9' 18"**

 Diametro tubolari **0,60 m**  
Tubular diameter **1' 95"**

 Camere stagne **5**  
T. compartments

 Persone **16**  
Persons

 Peso **700 Kg**  
Weight **1.543 lbs**

 Motorizzazione **1**  
Engine

 **HP** Min. **100 Hp**  
Min. power

 **HP** Max. **250 Hp**  
Max power

 Gambo **XL**  
Shaft Length

 Carburante **205 Lt**  
Fuel tank **54 Gal**

 Acqua opt. **45 Lt**  
Water tank opt. **12 Gal**

 Categoria **B**  
Category











# CAYMAN 21.0 SPORT

## CAYMAN LINE

 Lunghezza F.T. **6,45 m**  
Length overall **21' 20"**

 Larghezza F.T. **2,55 m**  
Beam **8' 4"**

 Diametro tubolari **0,60 m**  
Tubular diameter **1' 95"**

 Camere stagne **5**  
T. compartments

 Persone **14**  
Persons

 Peso **600 Kg**  
Weight **1.323 lbs**

 Motorizzazione **1**  
Engine

 **HP** **40 Hp**  
Min. power

 **HP** **150 Hp**  
Max power

 Gambo **L**  
Shaft Length

 Carburante **165 Lt**  
Fuel tank **28 Gal**

 Acqua **opt. 45 Lt**  
Water tank **opt. 12 Gal**

 Categoria **B**  
Category























# CAYMAN 19 SPORT

## CAYMAN LINE

	Lunghezza F.T. <b>5,95 m</b> Length overall <b>19' 5"</b>
	Larghezza F.T. <b>2,55 m</b> Beam <b>8' 4"</b>
	Diametro tubolari <b>0,60 m</b> Tubular diameter <b>1' 95"</b>
	Camere stagne <b>5</b> T. compartments
	Persone <b>12</b> Persons
	Peso <b>550 Kg</b> Weight <b>1.213 lbs</b>
	Motorizzazione <b>1</b> Engine
	Potenza Min. <b>40 Hp</b> Min. power
	Potenza Max <b>140 Hp</b> Max power
	Gambo <b>L</b> Shaft Length
	Carburante opt. <b>105 Lt</b> Fuel tank <b>opt. 28 Gal</b>
	Acqua opt. <b>45 Lt</b> Water tank <b>opt. 12 Gal</b>
	Categoria <b>B</b> Category
	









# CAYMAN ONE LUXURY TENDER

## CAYMAN LINE

 Lunghezza F.T. **3,65 m**

Length overall **12'**

 Larghezza F.T. **1,92 m**

Beam **6' 3"**

 Diametro tubolari **0,44 m**

Tubular diameter **1' 44"**

 Camere stagne **3**

T. compartments

 Persone **6**

Persons

 Peso **250 Kg**

Weight **551 lbs**

 Motorizzazione **1**

Engine

 Potenza Min. **20 Hp**

Min. power

 Potenza Max **60 Hp**

Max power

 Gambo **L**

Shaft Length

 Carburante opt. **25 Lt**

Fuel tank opt. **7 Gal**

 Acqua opt. **20 Lt**

Water tank opt. **5 Gal**

 Categoria **C**

Category





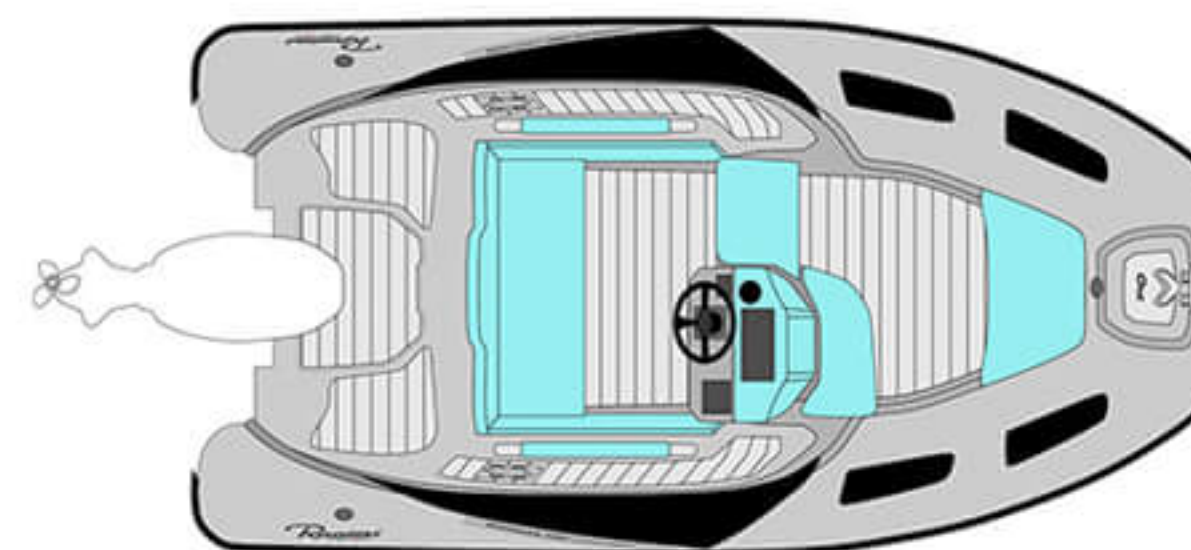
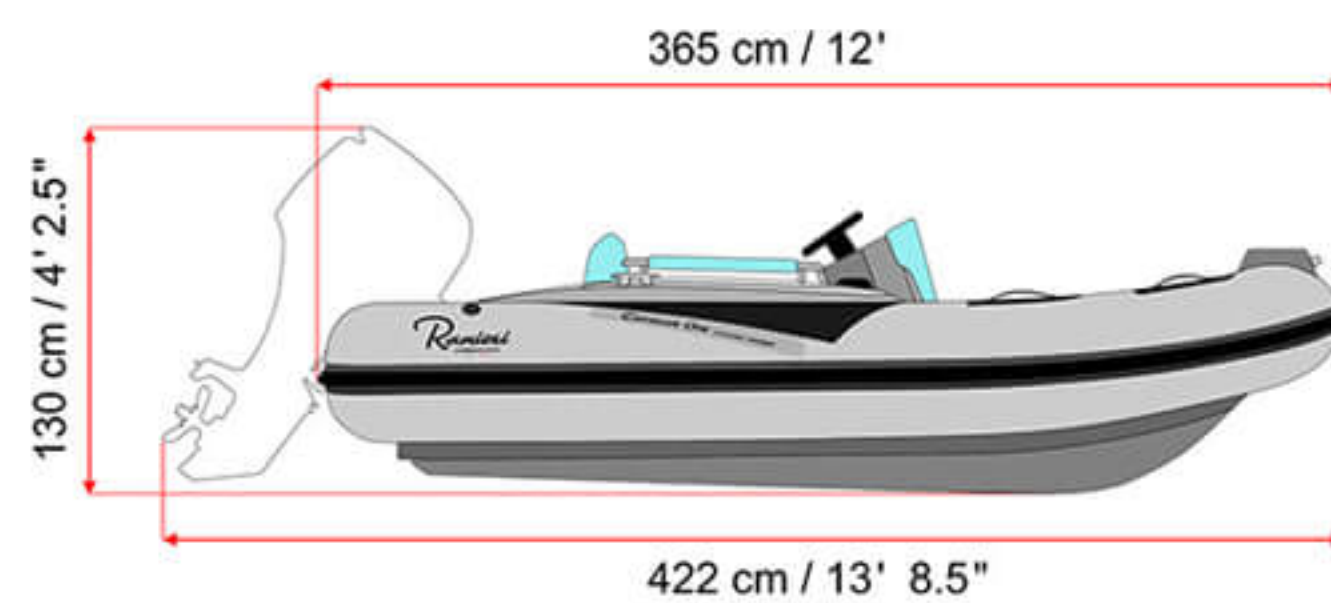
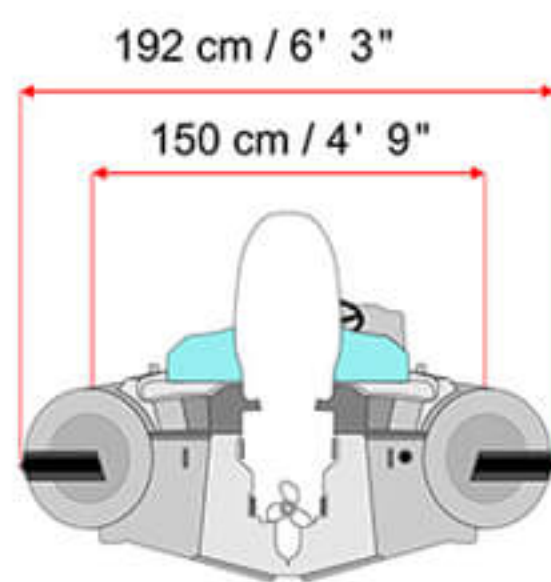





Ranieri  
450

Ranieri

CAYMAN 45.0 CRUISER









CAT. 2024

Motonautica F.lli Ranieri S.r.l.

Loc. Caldarello - 88068 SOVERATO (CZ) Italy  
Cantiere Tel (+39) 0967 25839 - Centro Prove Tel. (+39) 0967 21920  
info@ranieri-international.com - [www.ranieri-international.com](http://www.ranieri-international.com)



Tutte le caratteristiche relative all'intera gamma non sono vincolanti. Ranieri International si riserva il diritto di modificarle senza preavviso. Le imbarcazioni raffigurate possono essere equipaggiate con accessori optional.  
All features and data concerning our whole production are not binding. The shipyard Ranieri International reserves the right to modify them without advance notice. The boats shown can be equipped with additional options.